

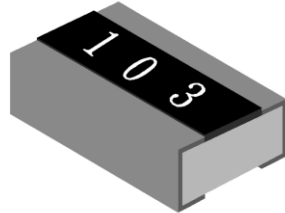

CRW Series Thick Film Wide Terminal Chip Resistor Product Specifications

Document No.	S-10-12-19-04
Released Date	2019/10/21
Page No.	1/10

Thick Film Wide Terminal Chip Resistor— CRW Series



Application

- Navigation equipment
- Power equipment: Power supply, Illumination equipment
- Indoor lighting, Central door locking

Features

- Small size and light weight
- Reliability, high quality
- Chip resistor of the wide terminal type.

Parts Number Explanation

Example:

CRW	0612	J	10K0	P	05	Z
Product Type	Size(Inch)	Resistor Tolerance	Resistors Value	Package	Quantity	Optional
CRW	0612 1020 1218 1225 2030	F : ±1% J : ±5%		P、Q : Paper Taping E : Embossed Taping B : Packed in a Bag	01 : 1000PCS 04 : 4000PCS 05 : 5000PCS	7:TCR±200PPM



CRW Series Thick Film Wide Terminal Chip Resistor Product Specifications

Document No.	S-10-12-19-04
Released Date	2019/10/21
Page No.	2/10

Standard Electrical Specifications

Type	Item	Rated Power at 70°C	Max Working Voltage	Max Overload Voltage	T.C.R. (PPM/°C)	Resistance Range	
						F(±1%)	J(±5%)
CRW0612	0.75 W	200V	400V	±400	1Ω ≤ R < 10Ω		
				±100	10Ω ≤ R ≤ 10MΩ		
CRW1020	1 W	200V	400V	±400	1Ω ≤ R < 10Ω		
				±100	10Ω ≤ R ≤ 10MΩ		
CRW1218	1 W	200V	400V	±400	1Ω ≤ R < 10Ω		
				±100	10Ω ≤ R ≤ 10MΩ		
CRW1225	2W	200V	400V	±400	1Ω ≤ R < 10Ω		
				±100	10Ω ≤ R ≤ 10MΩ		
CRW2030	3W	200V	400V	±400	1Ω ≤ R < 10Ω		
				±100	10Ω ≤ R ≤ 10MΩ		

- For non-standard parts, please contact our sales dept.
- Operating Temperature Range : -55°C ~ +155°C
- Type CRW0612/1020/1218/1225/2030 1Ω ≤ R < 10Ω optional code 「7」 is TCR: ±200PPM

Low Ohm Chip Resistor Electrical Specifications

Type	Item	Rated Power at 70°C	Rated Voltage Range	Max Overload Voltage	T.C.R. (PPM/°C)	Resistance Range (mΩ)
						F(±1%)、J(±5%)
CRW0612	0.75W	0.15~0.86V	2.154V	±1800	10 ≤ R < 50	
				±800	50 ≤ R < 100	
				±600	100 ≤ R < 1000	
CRW1020	1W	0.1~0.99V	2.475V	±1800	10 ≤ R < 50	
				±800	50 ≤ R < 100	
				±600	100 ≤ R < 1000	
CRW1218	1W	0.1~0.99V	2.475V	±1800	10 ≤ R < 50	
				±800	50 ≤ R < 100	
				±600	100 ≤ R < 1000	
CRW1225	2W	0.14~1.41V	3.518 V	±1800	10 ≤ R < 50	
				±800	50 ≤ R < 100	
				±600	100 ≤ R < 1000	
CRW2030	3W	0.17~1.72V	4.308V	±1800	10 ≤ R < 50	
				±800	50 ≤ R < 100	
				±600	100 ≤ R < 1000	

- For non-standard parts, please contact our sales dept.
- Operating Temperature Range : -55°C ~ +155°C



CRW Series Thick Film Wide Terminal Chip Resistor Product Specifications

Document No.	S-10-12-19-04
Released Date	2019/10/21
Page No.	3/10

■ Type Dimension

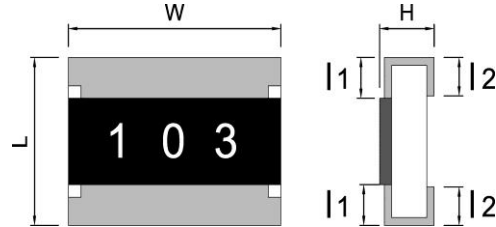

■ Dimension

Unit: mm

TYPE	L	W	H	l ₁	l ₂
CRW0612	1.60 ± 0.20	3.20 ± 0.20	0.55 ± 0.10	0.30 ± 0.20	0.50 ± 0.20
CRW1020	2.50 ± 0.20	5.00 ± 0.20	0.55 ± 0.10	0.40 ± 0.20	0.75 ± 0.20
CRW1218	3.10 ± 0.10	4.60 ± 0.10	0.55 ± 0.05	0.40 ± 0.20	0.50 ± 0.20
CRW1225	3.20 ± 0.20	6.50 ± 0.20	0.55 ± 0.20	0.40 ± 0.20	0.75 ± 0.20
CRW2030	5.10 ± 0.10	7.60 ± 0.10	1.20 ± 0.10	0.80 ± 0.20	0.80 ± 0.20

● General Information

■ Recommend Land Pattern Design

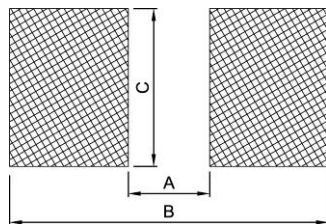

■ Dimension

Unit: mm

Type	0612	1020	1218	1225	2030
Item A	0.60	0.75	2.04	0.85	3.50
Item B	2.90	3.40	4.24	3.70	7.50
Item C	3.20	5.00	4.80	6.40	7.80



CRW Series Thick Film Wide Terminal Chip Resistor Product Specifications

Document No.	S-10-12-19-04
Released Date	2019/10/21
Page No.	4/10

■ Performance Characteristics

■ Power Derating Curve

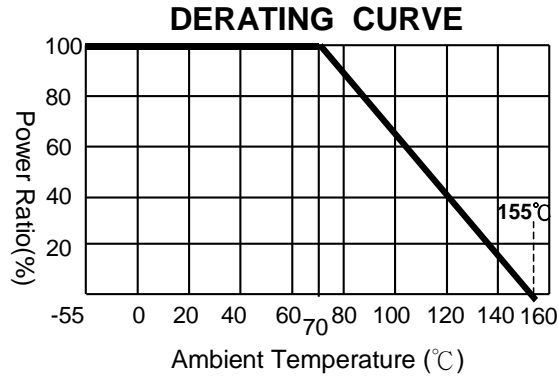

Power rating or current rating is in the case based on continuous full-load at ambient temperature of 70°C. For operation at ambient temperature in excess of 70°C, the load should be derated in accordance with figure of derating Curve.

■ Voltage Rating or Current Rating

Resistance Range: $\geq 1 \Omega$

Rated Voltage: The resistor shall have a DC continuous working voltage or a RMS AC continuous working voltage at commercial-line frequency and wave form corresponding to the power rating, as determined formula as following:

$$E(RCWV) = \sqrt{P \times R}$$

E=Rated voltage(V)
 P=Power rating(W)
 R=Nominal resistance(Ω)



CRW Series Thick Film Wide Terminal Chip Resistor Product Specifications

Document No.	S-10-12-19-04
Released Date	2019/10/21
Page No.	5/10

● Reliability Test and Requirement

Test Item	Test Method	Procedure	Requirements
Temperature Coefficient of Resistance (T.C.R)	JIS C 5201-1 clause 4.8	-55°C or +155°C, 25°C is the reference temperature	Refer to Ratings
Short Time Overload	JIS C 5201-1 clause 4.13	General : 2.5 times RCWV or Max. Overload voltage whichever is less for 5 seconds.	1% : $\pm(1.0\%+0.05\Omega)$ 5% : $\pm(2.0\%+0.1\Omega)$
IR Reflow	Sony SS-00254	<p>The graph shows a temperature profile over heating time. It starts at 50°C, rises to 150°C, then to 180°C in the 'Pre Heating Zone' (90 ± 30 s). It then rises to a peak of 250 ± 5°C (230°C or higher) in the 'Soldering Zone' (30 ± 10 s) before cooling down.</p>	1% : $\pm(1.0\%+0.05\Omega)$ 5% : $\pm(1.0\%+0.05\Omega)$
Leaching	Sony SS-00254-9	260±5°C for 30 seconds.	>95% Coverage
Soldering Heat	JIS C 5201-1 clause 4.18	260±5°C for 10 seconds.	1% : $\pm(0.5\%+0.05\Omega)$ 5% : $\pm(1.0\%+0.05\Omega)$
Temperature Cycling	JIS C 5201-1 clause 4.19	-55°C to +155°C, 5 cycles	1% : $\pm(0.5\%+0.05\Omega)$ 5% : $\pm(1.0\%+0.10\Omega)$
Electric Iron	Sony SS-00254-5	Preheating temperature : 350±10°C Electric iron preheating time : 3+1/-0 sec	1% : $\pm(1.0\%+0.05\Omega)$ 5% : $\pm(1.0\%+0.05\Omega)$
Resistance to Solvent	JIS C 5201-1 clause 4.29	The tested resistor be immersed into isopropyl alcohol of 20~25°C for 60 secs. Then the resistor is left in the room for 48 hrs.	1% : $\pm(0.5\%+0.05\Omega)$ 5% : $\pm(0.5\%+0.05\Omega)$
Load Life in Humidity	JIS C 5201-1 clause 4.24	40±2°C, 90~95% R.H. RCWV or Max. working voltage whichever is less for 1000 hrs with 1.5 hrs "ON" and 0.5 hr "OFF" .	1% : $\pm(1.0\%+0.05\Omega)$ 5% : $\pm(2.0\%+0.05\Omega)$
Load Life (Endurance)	JIS C 5201-1 clause 4.25	70±2°C, RCWV or Max. working voltage whichever is less for 1000 hrs with 1.5 hrs "ON" and 0.5 hr "OFF" .	1% : $\pm(1.0\%+0.05\Omega)$ 5% : $\pm(3.0\%+0.10\Omega)$
Insulation Resistance	JIS C 5201-1 clause 4.6	100V for 1 minute.	≥ 10GΩ
Terminal Bending Strength	JIS C 5201-1 clause 4.33	Bending once for 5 seconds D : 0612、1218、1020、1225、2030=2mm	1% : $\pm(1.0\%+0.05\Omega)$ 5% : $\pm(1.0\%+0.05\Omega)$



CRW Series Thick Film Wide Terminal Chip Resistor Product Specifications

Document No.	S-10-12-19-04
Released Date	2019/10/21
Page No.	6/10

Appendix For SMD Chip Resistor

● Packaging Information

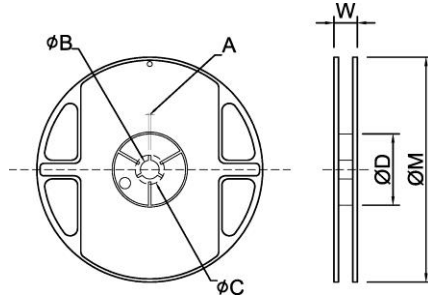

Dimension

Unit: mm

TYPE	SIZE		A	φB	φC	φD	W	φM
0612	7"	5K/Reel	2.0±0.5	13.5±1.0	21±1.0	60±1.0	11.5±2.0	178±2.0
1020/1218/1225	7"	4K/Reel	2.0±0.5	13.5±1.0	21±1.0	60±1.0	16.0±2.0	178±2.0
2030	7"	1K/Reel	2.0±0.5	13.5±1.0	21±1.0	60±1.0	19.0±2.0	178±2.0

● Tapping Specification

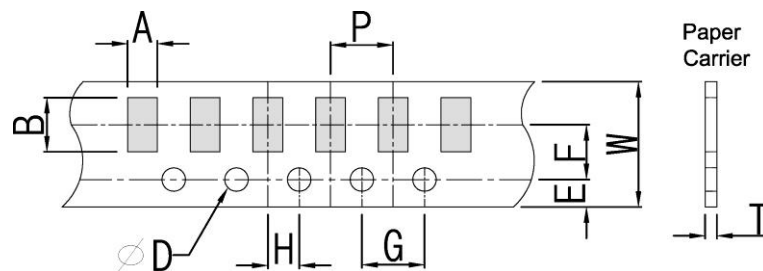

Dimension

Unit: mm

Packaging	Type	A	B	W	E	F	G	H	T	φD	P
Paper Type	0612	1.90±0.2	3.50±0.2	8.0±0.2	1.75±0.1	3.5±0.05	4.0±0.1	2.0±0.05	0.75±0.1	1.50 ^{+0.10} ₋₀	4.0±0.1



CRW Series Thick Film Wide Terminal Chip Resistor Product Specifications

Document No.	S-10-12-19-04
Released Date	2019/10/21
Page No.	7/10

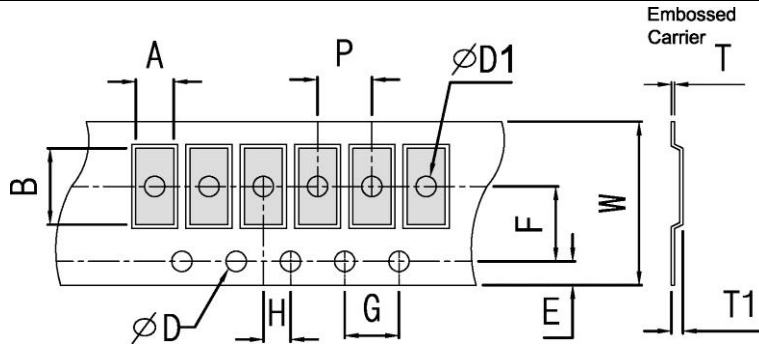

Dimension

Unit: mm

Packaging	Type	A	B	W	E	F	G	H	T	ϕD	$\phi D1$	T1	P
Embossed Type	1020	2.80±0.2	5.60±0.2	12±0.1	1.75±0.1	5.5±0.05	4.0±0.1	2.0±0.05	0.23±0.1	1.50 ^{+0.10} ₋₀	1.50±0.1	0.85±0.15	4.0±0.1
	1225	3.40±0.2	6.70±0.2	12±0.1	1.75±0.1	5.5±0.05	4.0±0.1	2.0±0.05	0.23±0.1				
	1218	3.30±0.2	4.60±0.2	12±0.1	1.75±0.1	5.5±0.05	4.0±0.1	2.0±0.05	0.23±0.1				
	2030	5.50±0.2	7.90±0.2	16±0.1	1.75±0.1	7.5±0.05	4.0±0.1	2.0±0.05	0.25±0.1				

Packing Material Data/Storage Data

Front & Back Lead Dimension

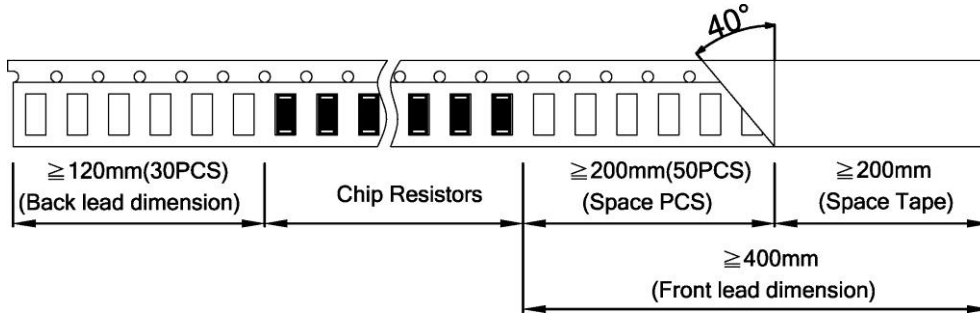

Top Adhesive Peel Off Strength : 10~70g

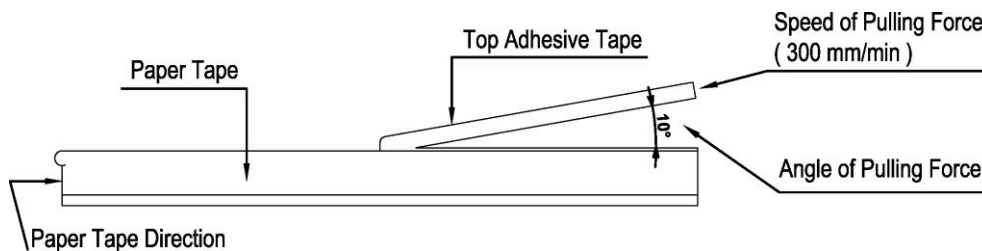



CRW Series Thick Film Wide Terminal Chip Resistor Product Specifications

Document No.	S-10-12-19-04
Released Date	2019/10/21
Page No.	8/10

■ Package

Inner Box Size	
Reel	Size H(mm)
1	13
2	24
3	36
5	60
10	113

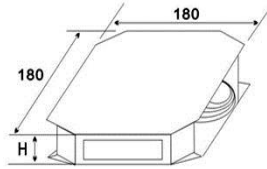

External Box Size			
Contain (Kpcs)	Length (mm)	Width (mm)	Height (mm)
25K	180	180	60
50K	180	180	110
150K	430	200	200
300K	400	400	200

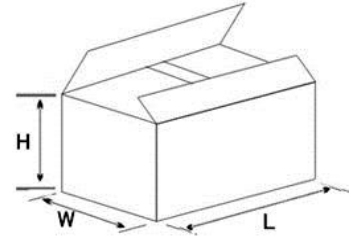

■ Storage Data :

Storage time at the environment temp: $25\pm 5^{\circ}\text{C}$ & humidity: $60\pm 20\%$ is valid for one year from the date of delivery.



CRW Series Thick Film Wide Terminal Chip Resistor Product Specifications

Document No.	S-10-12-19-04
Released Date	2019/10/21
Page No.	9/10

■ Product Testing Method:

Our products are tested with our company's tapping & testing equipments by using four-foot probe to touch at the back of both electrodes. Supposed different testing points or methods are requested, please advise beforehand and customized-made production is available.

■ Standard Resistance Values in a Decade

Marking code:

- 1%: marking code, please refer to E96 and E24 data form as below
 Ex: 120K, The marking code is 1203 in E24
 121K, The marking code is 1213 in E96
- 5%: marking code, please refer to E24 data form as below
 Ex: 120K, The marking code is 124 in E24
- Note: jumper zero ohm resistor marking code is one 「0」 (except type below 0402).

E192	E96	E48	E192	E96	E48	E192	E96	E48	E192	E96	E48	E192	E96	E48	
100	100	100	169	169	169	287	287	287	487	487	487	825	825	825	
101			172			291			493			835			
102	102		174	174		294	294		499	499		845	845		
104			176			298			505			856			
105	105	105	178	178	178	301	301	301	511	511	511	866	866	866	
106			180			305			517			876			
107	107		182	182		309	309		523	523		887	887		
109			184			312			530			898			
110	110	110	187	187	187	316	316	316	536	536	536	909	909	909	
111			189			320			542			920			
113	113		191	191		324	324		549	549		931	931		
114			193			328			556			942			
115	115	115	196	196	196	332	332	332	562	562	562	953	953	953	
117			198			336			569			965			
118	118		200	200		340	340		576	576		976	976		
120			203			344			583			988			
121	121	121	205	205	205	348	348	348	590	590	590				
123			208			352			597						
124	124		210	210		357	357		604	604		E24	E12	E6	E3
126			213			361			612			10	10	10	10
127	127	127	215	215	215	365	365	365	619	619	619	11			
129			218			370			626			12	12		
130	130		221	221		374	374		634	634		13			
132			223			379			642			15	15	15	
133	133	133	226	226	226	383	383	383	649	649	649	16			
135			229			388			657			18	18		
137	137		232	232		392	392		665	665		20			
138			234			397			673			22	22	22	22
140	140	140	237	237	237	402	402	402	681	681	681	24			
142			240			407			690			27	27		
143	143		243	243		412	412		698	698		30			
145			246			417			706			33	33	33	
147	147	147	249	249	249	422	422	422	715	715	715	36			
149			252			427			723			39	39		
150	150		255	255		432	432		732	732		43			
152			258			437			741			47	47	47	47
154	154	154	261	261	261	442	442	442	750	750	750	51			
156			264			448			759			56	56		
158	158		267	267		453	453		768	768		62			
160			271			459			777			68	68	68	
162	162	162	274	274	274	464	464	464	787	787	787	75			
164			277			470			796			82	82		
165	165		280	280		475	475		806	806		91			
167			284			481			816						

According to IEC publication 63



CRW Series Thick Film Wide Terminal Chip Resistor Product Specifications

Document No.	S-10-12-19-04
Released Date	2019/10/21
Page No.	10/10

■ mΩ Resistance Codes

Resistance	Code	0603 Code	Resistance	Code	0603 Code	Resistance	Code	0603 Code	Resistance	Code	0603 Code	Resistance	Code	0603 Code
10mΩ	R010	010	65mΩ	R065	065	0.12Ω	R120	R12	0.27Ω	R270	R27	0.56Ω	R560	R56
15mΩ	R015	015	68mΩ	R068	068	0.13Ω	R130	R13	0.30Ω	R300	R30	0.60Ω	R600	R60
20mΩ	R020	020	70mΩ	R070	070	0.15Ω	R150	R15	0.33Ω	R330	R33	0.65Ω	R650	R65
30mΩ	R030	030	75mΩ	R075	075	0.16Ω	R160	R16	0.36Ω	R360	R36	0.68Ω	R680	R68
40mΩ	R040	040	80mΩ	R080	080	0.18Ω	R180	R18	0.40Ω	R400	R40	0.70Ω	R700	R70
50mΩ	R050	050	90mΩ	R090	090	0.20Ω	R200	R20	0.43Ω	R430	R43	0.75Ω	R750	R75
56mΩ	R056	056	0.10Ω	R100	R10	0.22Ω	R220	R22	0.47Ω	R470	R47	0.80Ω	R800	R80
60mΩ	R060	060	0.11Ω	R110	R11	0.25Ω	R250	R25	0.50Ω	R500	R50	0.90Ω	R900	R90