

## DTCxxxxUA-HF Series

RoHS Device  
Halogen Free

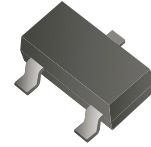

### Features

- Epitaxial planar die construction.
- Built-in biasing resistors,  $R_1 \neq R_2$ .

### Mechanical data

- Case: SOT-323, molded plastic.

### Circuit Diagram

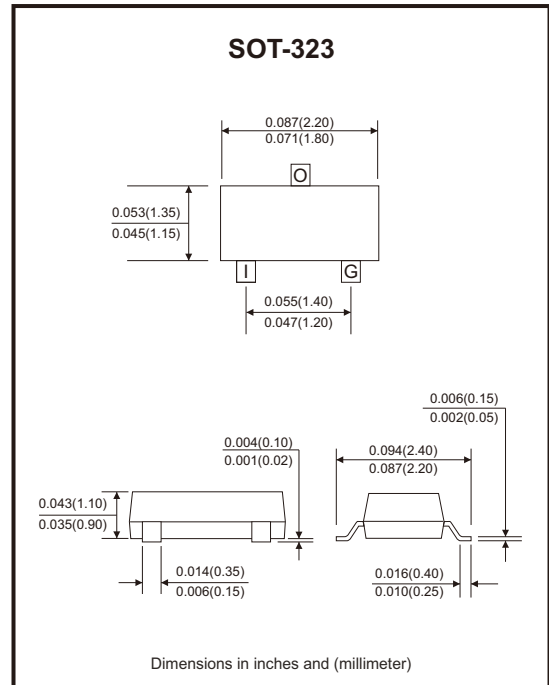
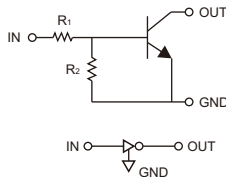

### Maximum Ratings (at $T_a=25^\circ\text{C}$ unless otherwise noted)

Parameter	Symbol	Value	Units
Supply voltage	$V_{CC}$	50	V
Input voltage	$V_{IN}$	-5 to +10 -10 to +30 -6 to +40 -5 to +12 -5 to +12 -7 to +20 -5 to +30	V
Output current	$I_o$	100 100 70 100 100 100 100	mA
Output current	$I_c$ (Max.)	100	mA
Power dissipation	$P_d$	200	mW
Thermal resistance, junction to ambient air	$R_{\theta JA}$	625	$^\circ\text{C/W}$
Operating and storage and temperature range	$T_j, T_{STG}$	-55 to +150	$^\circ\text{C}$

## Electrical Characteristics (at Ta=25°C unless otherwise noted)

Parameter	Symbol	Test conditions	Min	Typ	Max	Units	
Input voltage	V <sub>I(off)</sub>	V <sub>CC</sub> = 5V, I <sub>O</sub> = 100μA	DTC113ZUA-HF	0.3			V
			DTC114WUA-HF	0.8			
			DTC114YUA-HF	0.3			
			DTC123JUA-HF	0.5			
			DTC123YUA-HF	0.3			
			DTC143XUA-HF	0.3			
			DTC143ZUA-HF	0.5			
Input voltage	V <sub>I(on)</sub>	V <sub>O</sub> = 0.3V, I <sub>O</sub> = 20mA V <sub>O</sub> = 0.3V, I <sub>O</sub> = 2mA V <sub>O</sub> = 0.3V, I <sub>O</sub> = 1mA V <sub>O</sub> = 0.3V, I <sub>O</sub> = 5mA V <sub>O</sub> = 0.3V, I <sub>O</sub> = 20mA V <sub>O</sub> = 0.3V, I <sub>O</sub> = 20mA V <sub>O</sub> = 0.3V, I <sub>O</sub> = 5mA			3.0		
					3.0		
					1.4		
					1.1		
					3.0		
					2.5		
					1.3		
Output voltage	V <sub>O(on)</sub>	I <sub>O</sub> / I <sub>I</sub> = 5mA / 0.25mA		0.1	0.3	V	
		I <sub>O</sub> / I <sub>I</sub> = 10mA / 0.5mA					
Input current	I <sub>I</sub>	V <sub>I</sub> = 5V			7.2	mA	
					0.88		
					0.88		
					3.6		
					3.8		
					1.8		
					1.8		
Output current	I <sub>O(off)</sub>	V <sub>CC</sub> = 50V, V <sub>I</sub> = 0V			0.5	μA	
DC current gain	G <sub>I</sub>	V <sub>O</sub> = 5V, I <sub>O</sub> = 10mA	DTC113ZUA-HF	33			
			DTC114WUA-HF	24			
			DTC114YUA-HF	68			
			DTC123JUA-HF	80			
			DTC123YUA-HF	33			
			DTC143XUA-HF	30			
			DTC143ZUA-HF	80			
Input resistor	R <sub>1</sub> (R <sub>2</sub> )			1(10)		kΩ	
				10(4.7)			
				10(47)			
				2.2(47)			
				2.2(10)			
				4.7(10)			
				4.7(47)			
Input resistor (R <sub>1</sub> ) tolerance	ΔR <sub>1</sub>		-30		+30	%	
Resistance ratio tolerance	ΔR <sub>2</sub> /R <sub>1</sub>		-20		+20	%	
Gain-bandwidth product	f <sub>r</sub>	V <sub>CE</sub> = 10V, I <sub>E</sub> = 5mA, f = 100MHz		250		MHz	

## Rating and Characteristic Curves (DTCxxxxUA-HF Series)

Fig.1 - Derating Curve

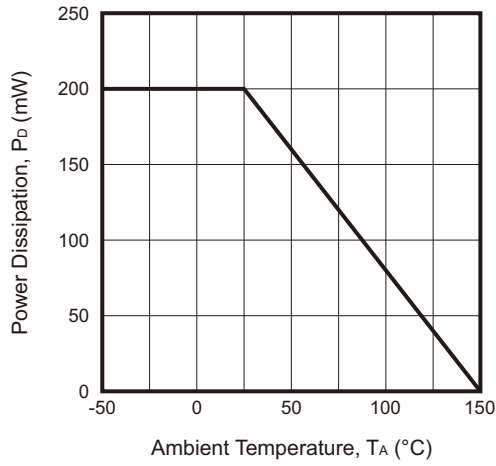

Fig.2 -  $V_{CE(SAT)}$  vs.  $I_c$

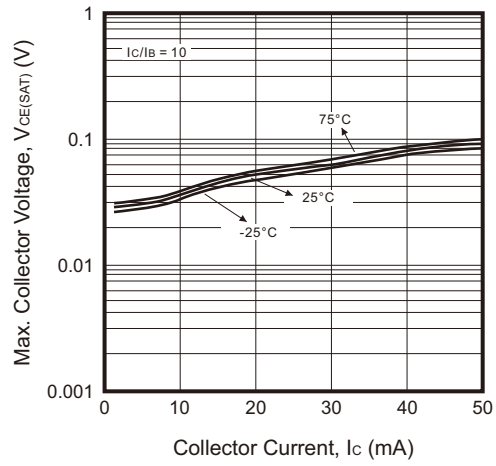

Fig.3 - DC Current Gain

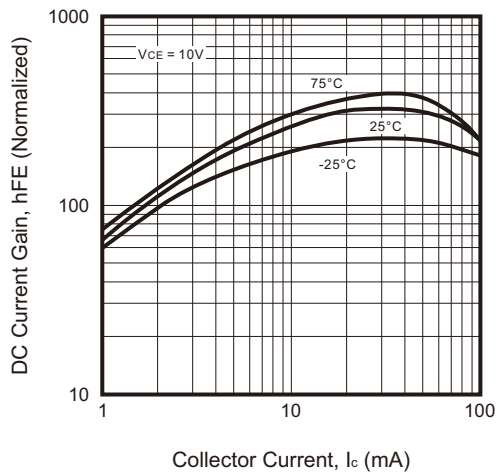

Fig.4 - Output Capacitance

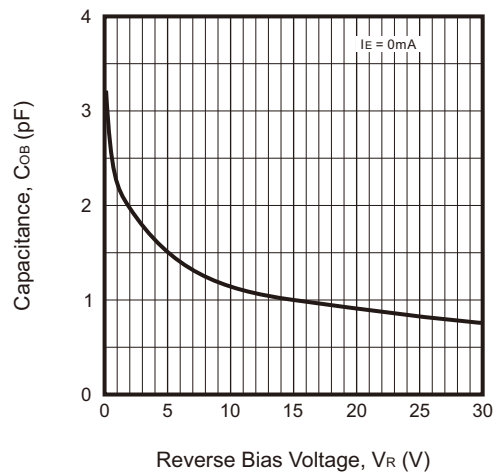

Fig.5 - Collector Current vs. Input Voltage

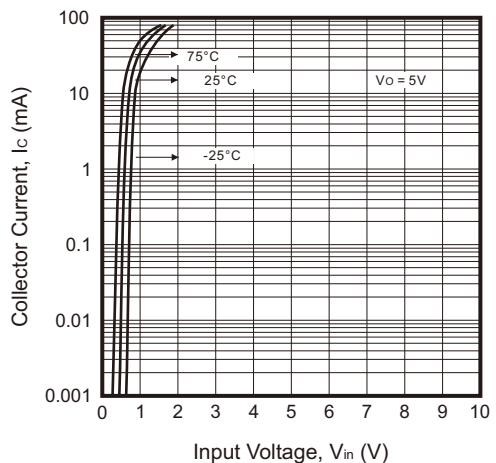
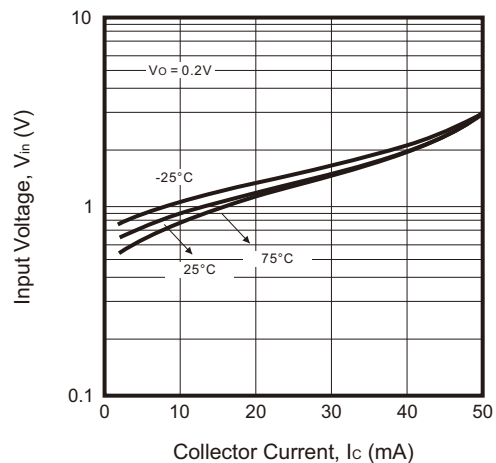
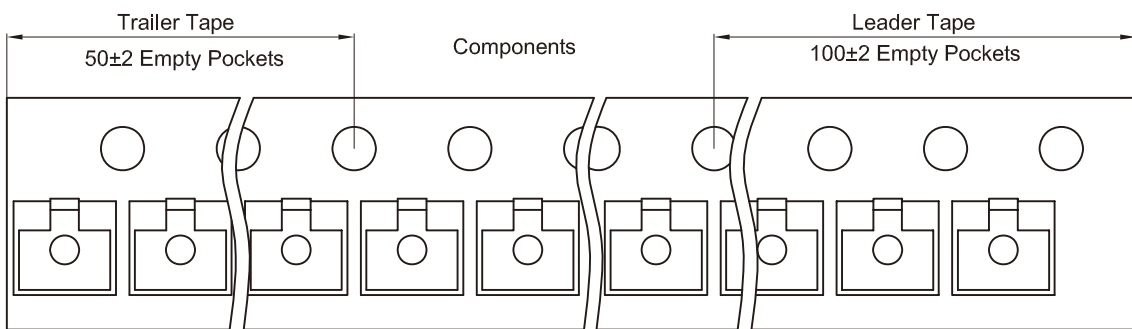
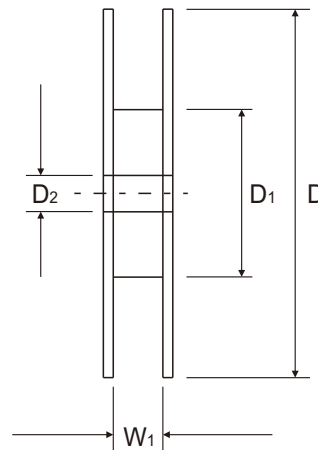
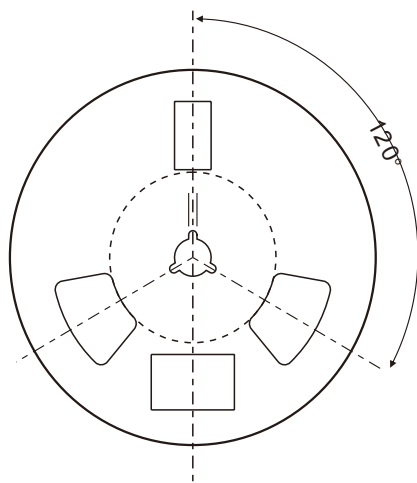
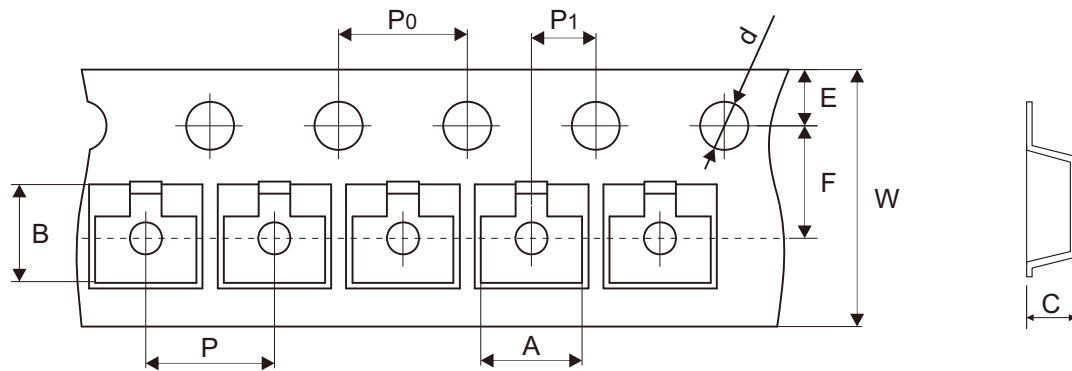

Fig.6 - Input Voltage vs. Collector Current



Company reserves the right to improve product design, functions and reliability without notice.

## Reel Taping Specification



SOT-323	SYMBOL	A	B	C	d	D	D1	D2
	(mm)	2.25 ± 0.10	2.55 ± 0.10	1.20 ± 0.10	1.50 ± 0.10	178.00 ± 1.00	54.00 ± 0.50	13.00 ± 0.50
	(inch)	0.089 ± 0.004	0.100 ± 0.004	0.047 ± 0.004	0.059 ± 0.004	7.008 ± 0.039	2.126 ± 0.020	0.512 ± 0.020

SOT-323	SYMBOL	E	F	P	P0	P1	W	W1
	(mm)	1.75 ± 0.10	3.50 ± 0.05	4.00 ± 0.10	4.00 ± 0.10	2.00 ± 0.05	8.00 + 0.30 - 0.10	9.50 ± 1.00
	(inch)	0.069 ± 0.004	0.138 ± 0.002	0.157 ± 0.004	0.157 ± 0.004	0.079 ± 0.002	0.315 + 0.012 - 0.004	0.374 ± 0.039

Company reserves the right to improve product design, functions and reliability without notice.

REV:A

## Marking Code

Part Number	Marking Code
DTC113ZUA-HF	E21
DTC114WUA-HF	84
DTC114YUA-HF	64
DTC123JUA-HF	E42
DTC123YUA-HF	62
DTC143XUA-HF	43•
DTC143ZUA-HF	E23

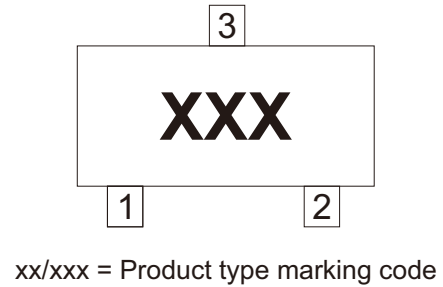

## Suggested PAD Layout

SIZE	SOT-323	
	(mm)	(inch)
A	0.90	0.035
B	0.70	0.028
C	1.30	0.051
D	1.90	0.075

Note: 1.The pad layout is for reference purposes only.

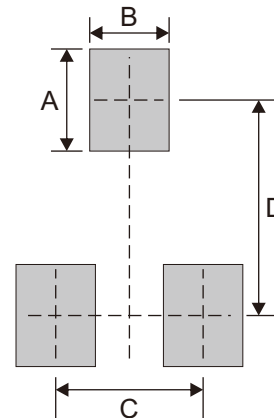

## Standard Packaging

Case Type	REEL PACK	
	REEL (pcs)	Reel Size (inch)
SOT-323	3,000	7