

## FEATURES

- Wide range of supply voltages
- Low supply current drain independent of supply voltage
- Low input biasing current
- Low input offset voltage and offset current
- Input common-mode voltage range includes ground
- Differential input voltage range equal to the power supply voltage
- DC voltage gain 100V/mV Typ.
- Internally frequency compensation

### SOP-8 / DIP-8 Pin Configuration

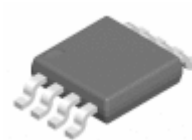

SOP-8 PKG



DIP-8 PKG

### ORDERING INFORMATION

Device	Package
LM2904D	SOP-8
LM2904N	DIP-8

## DESCRIPTION

The LM2904 consists of two independent, high gain, internally frequency compensated operational amplifiers which were designed specifically to operate from a single power supply over a wide range of voltages. Operation from split power supplies is also possible and the low power supply current drain is independent of the magnitude of the power supply voltage.

Application areas include transducer amplifiers, DC gain blocks and all the conventional op amp circuits.

## ABSOLUTE MAXIMUM RATING

CHARACTERISTIC	SYMBOL	MIN.	MAX.	UNIT
Supply Voltage	$V_{CC}$	-	45	V
Input Voltage	$V_{IN}$	-0.3	45	V
Input Current ( $V_{IN} = -0.3V$ )	$I_{IN}$	-	50	mA
Operating Temperature Range	$T_{OPR}$	-40	125	°C

## RECOMMENDED OPERATING CONDITION

CHARACTERISTIC		SYMBOL	MIN.	MAX.	UNIT
Supply Voltage	Single	$V_{CC}$	5	40	V
	Dual	$V_{CC+}$	+2.5	+20	
		$V_{CC-}$	-2.5	-20	V

## ORDERING INFORMATION

Package	Order No.	Description	Supply As	Status
SOP-8	LM2904D	Dual Operational Amplifier	Reel	Active
DIP-8	LM2904N	Dual Operational Amplifier	Tube	Contact us

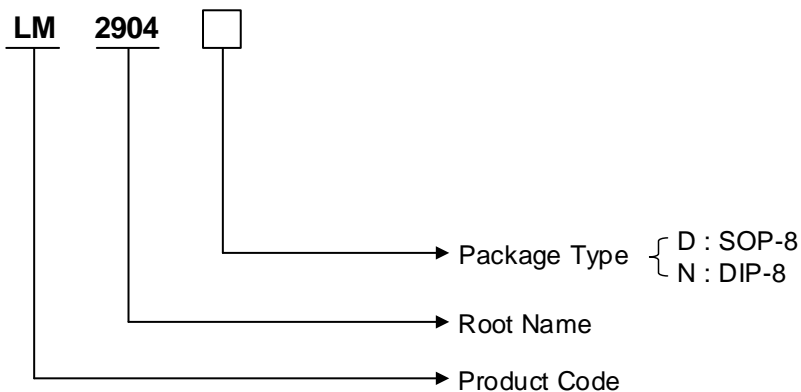

## PIN CONFIGURATION

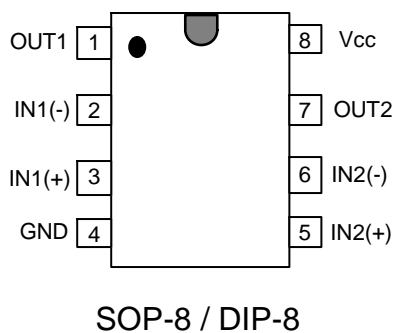

## ELECTRICAL CHARACTERISTICS

At specified free-air temperature,  $V_{CC}=5V$  (unless otherwise noted)

PARAMETER	TEST CONDITIONS*	MIN	TYP	MAX	UNIT
$V_{IO}$ Input offset voltage	$V_{CC}=5V$ to MAX, $V_{IC}=V_{ICR}$ min, $V_O=1.4V$	25°C	3	7	mV
		Full range		9	
$\alpha V_{IO}$ Average temperature coefficient of input offset voltage		Full range	7		$\mu V/^\circ C$
$I_{IO}$ Input offset current	$V_O=1.4V$	25°C	2	50	nA
		Full range		150	
$\alpha I_{IO}$ Average temperature coefficient of input offset current		Full range	10		$pA/^\circ C$
$I_{IB}$ Input bias current	$V_O=1.4V$	25°C	-20	-250	nA
		Full range		-500	
$V_{ICR}$ Common-mode input voltage range	$V_{CC}=5V$ to MAX	25°C	0	$V_{CC}-1.5$	V
		Full range	0	$V_{CC}-2.0$	
$V_{OH}$ High-level output voltage	$V_{CC}=MAX, R_L=2k\Omega$	Full range	26		V
	$V_{CC}=MAX, R_L \geq 10k\Omega$	Full range	27	28	
$V_{OL}$ Low-level output voltage	$R_L \geq 10k\Omega$	Full range	5	20	mV
$A_{VD}$ Large-signal differential voltage amplification	$V_{CC}=15V$ $V_O=1V$ to 11V $R_L \geq 2k\Omega$	25°C	25	100	V/mV
		Full range	15		
$CMRR$ Common-mode rejection ratio	$V_{CC} = 5 V$ to MAX, $V_{IC} = V_{ICR}$ min	25°C	65	80	dB
$k_{SVR}$ Supply voltage rejection ratio ( $\Delta V_{CC}/\Delta V_{IO}$ )	$V_{CC} = 5 V$ to MAX	25°C	65	100	dB
$V_{O1}/V_{O2}$ Crosstalk attenuation	$f=1$ kHz to 20 kHz	25°C		120	dB
$I_O$ Output current	$V_{CC}=15V,$ $V_{ID}=1V, V_O=0V$	25°C	-30	-50	mA
		Full range	-20		
	$V_{CC}=15V,$ $V_{ID}=-1V, V_O=15V$	25°C	15	35	mA
		Full range	7		
	$V_{CC} = 15 V,$ $V_{ID} = -1 V, V_O = 2V$	25°C	15	28	mA
$V_{ID} = -1 V, V_O = 200mV$	25°C	12	50	$\mu A$	
$I_{OS}$ Short-circuit output current	$V_{ID} = -1 V, V_O = 15 V$	25°C	50	70	mA
$I_{CC}$ Supply current (two amplifiers)	$V_O = 2.5 V, \text{No load}$	Full range	0.7	1.2	mA
	$V_{CC} = MAX,$ $V_O = 0.5V_{CC}, \text{No load}$	Full range	1	2	

\* All characteristics are measured under open-loop conditions with zero common-mode input voltage unless otherwise specified.

"MAX"  $V_{CC}$  for testing purposes is 36 V,  $V_{CCabsmax} = 45 V$ , Temperature full range is  $-40^\circ C$  to  $+125^\circ C$ .

**ELECTRICAL CHARACTERISTICS** (CONTINUED)At specified free-air temperature,  $V_{CC}=5V$  (unless otherwise noted)

PARAMETER	TEST CONDITIONS*	MIN	TYP	MAX	UNIT
Slew rate	$V_{CC}=15V$ , $V_{IN}=0.5$ to $3V$ , $R_L=2k\Omega$ , $C_L=100pF$ , unity gain		0.7		V/us
Gain bandwidth	$V_{CC}=30V$ , $f=100kHz$ , $V_{IN}=10mV$ , $R_L=2k\Omega$ , $C_L=100pF$		700		kHz
Total harmonic distortion	$f = 1kHz$ , $A_V = 20dB$ , $R_L=2k\Omega$ , $V_O = 2V_{pp}$ , $C_L=100pF$		0.04		%

TYPICAL ELECTRICAL CHARACTERISTICS

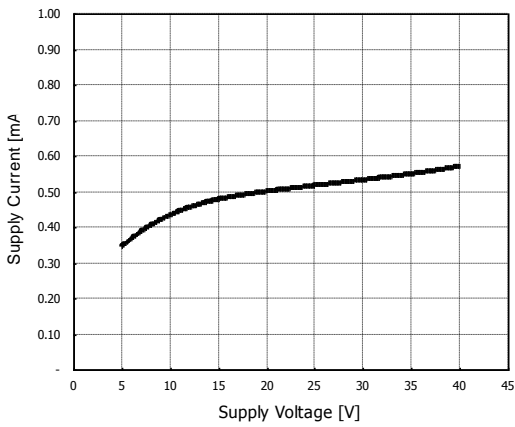

Supply current vs. Supply voltage

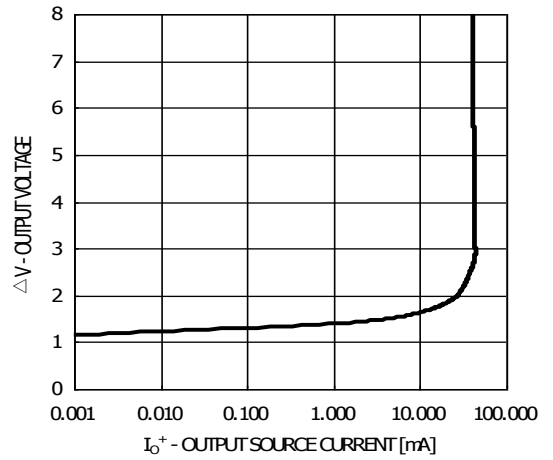

Current Sourcing vs. Output Characteristics

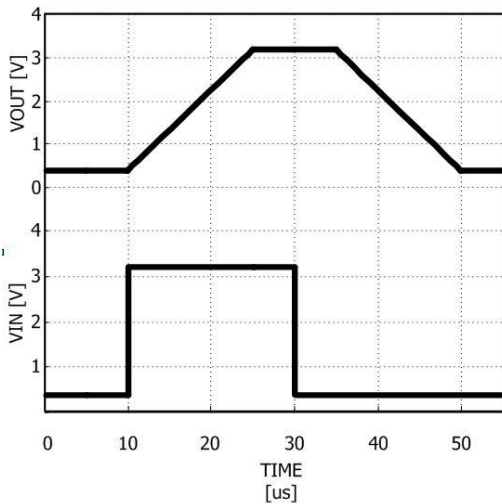

Voltage Follower Pulse Response

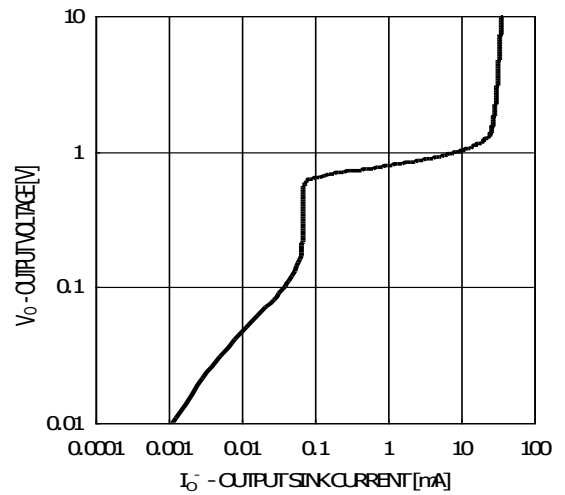

Current Sinking vs. Output Characteristics

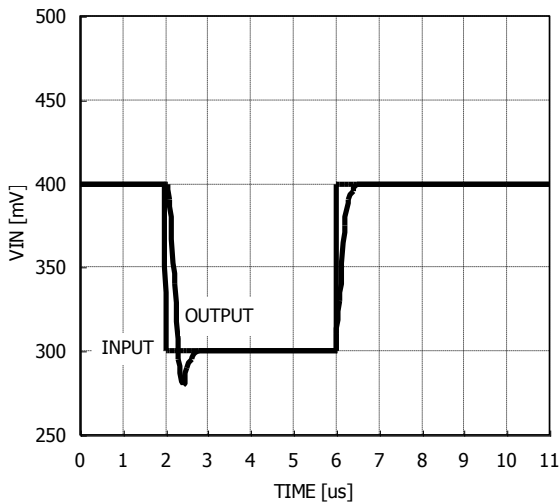

Voltage Follower Pulse Response (Small Signal)

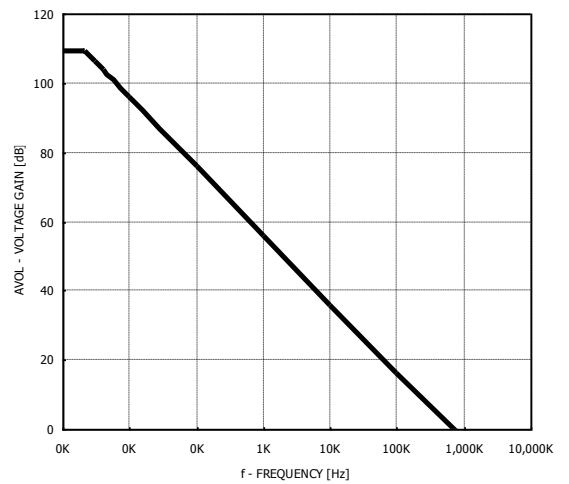

Open Loop Frequency Response

## REVISION NOTICE

The description in this data sheet can be revised without any notice to describe its electrical characteristics properly.