

FEATURES

- Wide range of supply voltages
- Low supply current drain independent of supply voltage
- Low input biasing current
- Low input offset voltage and offset current
- Input common-mode voltage range includes ground
- Differential input voltage range equal to the power supply voltage
- DC voltage gain 100V/mV Typ.
- Internally frequency compensation

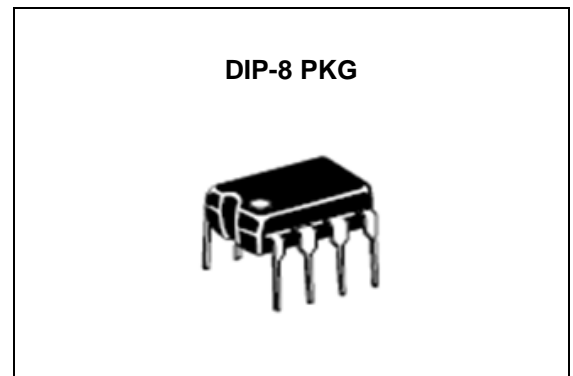

ORDERING INFORMATION

Device	Package
LM358N	DIP-8
LM358GN	DIP-8

DESCRIPTION

The LM358N consists of two independent, high gain, internally frequency compensated operational amplifiers which were designed specifically to operate from a single power supply over a wide range of voltages. Operation from split power supplies is also possible and the low power supply current drain is independent of the magnitude of the power supply voltage.

Application areas include transducer amplifiers, DC gain blocks and all the conventional op amp circuits.

ABSOLUTE MAXIMUM RATING

CHARACTERISTIC	SYMBOL	MIN.	MAX.	UNIT
Supply Voltage	V_{CC}	-	45	V
Input Voltage	V_{IN}	-0.3	45	V
Input Current ($V_{IN} = -0.3V$)	I_{IN}	-	50	mA
Operating Temperature Range	T_{OPR}	-40	125	°C

RECOMMENDED OPERATING CONDITION

CHARACTERISTIC		SYMBOL	MIN.	MAX.	UNIT
Supply Voltage	Single	V_{CC}	5	40	V
	Dual	V_{CC+}	+2.5	+20	V
		V_{CC-}	-2.5	-20	V

ORDERING INFORMATION

Package	Order No.	Description	Supply As	Status
DIP-8	LM358N	Dual Operational Amplifier, Pb Free	Tube	Active
DIP-8	LM358GN	Dual Operational Amplifier, Halogen Free	Tube	Active

PIN CONFIGURATION

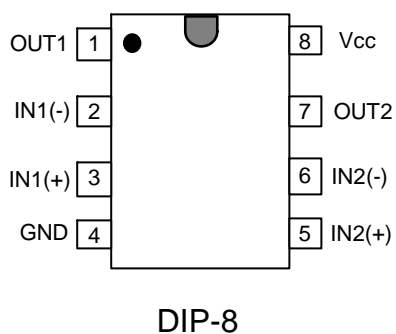

ELECTRICAL CHARACTERISTICS

At specified free-air temperature, $V_{CC}=5V$ (unless otherwise noted)

PARAMETER	TEST CONDITIONS*	MIN	TYP	MAX	UNIT	
V_{IO} Input offset voltage	$V_{CC}=5V$ to MAX, $V_{IC}=V_{ICR}$ min, $V_O=1.4V$	25 °C	3	7	mV	
		Full range		9		
αV_{IO} Average temperature coefficient of input offset voltage		Full range	7		$\mu V/^\circ C$	
I_{IO} Input offset current	$V_O=1.4V$	25 °C	2	50	nA	
		Full range		150		
αI_{IO} Average temperature coefficient of input offset current		Full range	10		$pA/^\circ C$	
I_{IB} Input bias current	$V_O=1.4V$	25 °C	-20	-250	nA	
		Full range		-500		
V_{ICR} Common-mode input voltage range	$V_{CC}=5V$ to MAX	25 °C	0	VCC-1.5	V	
		Full range	0	VCC-2.0		
V_{OH} High-level output voltage	$V_{CC}=MAX, R_L=2k\Omega$	Full range	26		V	
	$V_{CC}=MAX, R_L \geq 10k\Omega$	Full range	27	28		
V_{OL} Low-level output voltage	$R_L \geq 10k\Omega$	Full range	5	20	mV	
A_{VD} Large-signal differential voltage amplification	$V_{CC}=15V$ $V_O=1V$ to 11V $R_L \geq 2k\Omega$	25 °C	25	100	V/mV	
		Full range	15			
CMRR Common-mode rejection ratio	$V_{CC} = 5 V$ to MAX, $V_{IC} = V_{ICR}$ min	25 °C	65	80	dB	
k_{SVR} Supply voltage rejection ratio ($\Delta V_{CC}/\Delta V_{IO}$)	$V_{CC} = 5 V$ to MAX	25 °C	65	100	dB	
V_{O1}/V_{O2} Crosstalk attenuation	$f=1$ kHz to 20 kHz	25 °C		120	dB	
I_O Output current	$V_{CC}=15V,$ $V_{ID}=1V, V_O=0V$	25 °C	-30	-50	mA	
		Full range	-20			
	$V_{CC}=15V,$ $V_{ID}= -1V, V_O=15V$	25 °C	15	35	mA	
		Full range	7			
	$V_{CC} = 15 V,$ $V_{ID}= -1 V, V_O= 2V$	25 °C	15	28	mA	
$V_{ID}= -1 V, V_O= 200mV$	25 °C	12	50	μA		
I_{OS} Short-circuit output current	$V_{ID} = -1 V, V_O = 15 V$	25 °C		50	70	mA
I_{CC} Supply current (two amplifiers)	$V_O=2.5 V, \text{No load}$	Full range		0.7	1.2	mA
	$V_{CC} = MAX,$ $V_O = 0.5V_{CC}, \text{No load}$	Full range		1	2	

* All characteristics are measured under open-loop conditions with zero common-mode input voltage unless otherwise specified.

"MAX" V_{CC} for testing purposes is 36V, $V_{CCmax} = 45V$, Temperature full range is -40 °C to +125 °C.

ELECTRICAL CHARACTERISTICS (CONTINUED)At specified free-air temperature, $V_{CC}=5V$ (unless otherwise noted)

PARAMETER	TEST CONDITIONS*	MIN	TYP	MAX	UNIT
Slew rate	$V_{CC}=15V$, $V_{IN}=0.5$ to $3V$, $R_L=2k\Omega$, $C_L=100pF$, unity gain		0.7		V/us
Gain bandwidth	$V_{CC}=30V$, $f=100kHz$, $V_{IN}=10mV$, $R_L=2k\Omega$, $C_L=100pF$		700		kHz
Total harmonic distortion	$f = 1kHz$, $A_V = 20dB$, $R_L=2k\Omega$, $V_O = 2V_{pp}$, $C_L=100pF$		0.04		%

TYPICAL ELECTRICAL CHARACTERISTICS

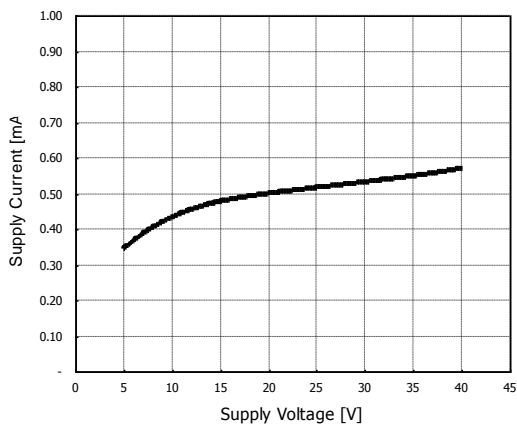

Supply current vs. Supply voltage

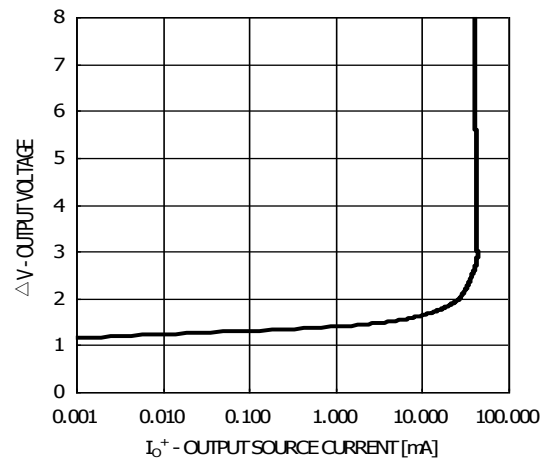

Current Sourcing vs. Output Characteristics

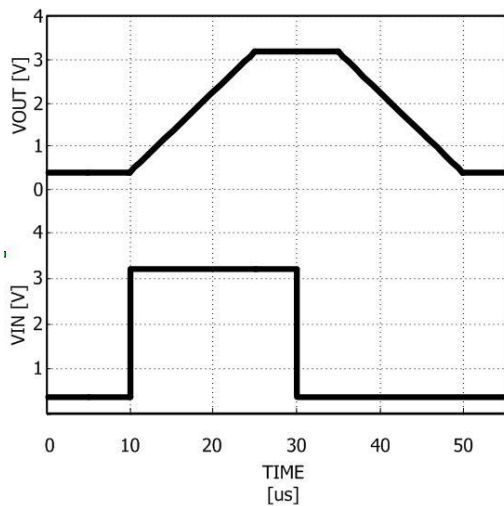

Voltage Follower Pulse Response

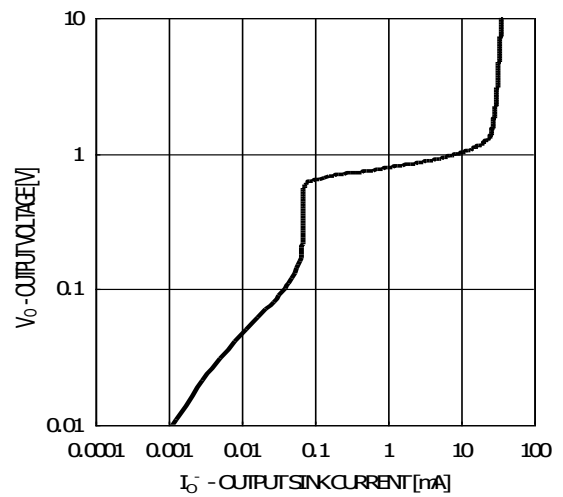

Current Sinking vs. Output Characteristics

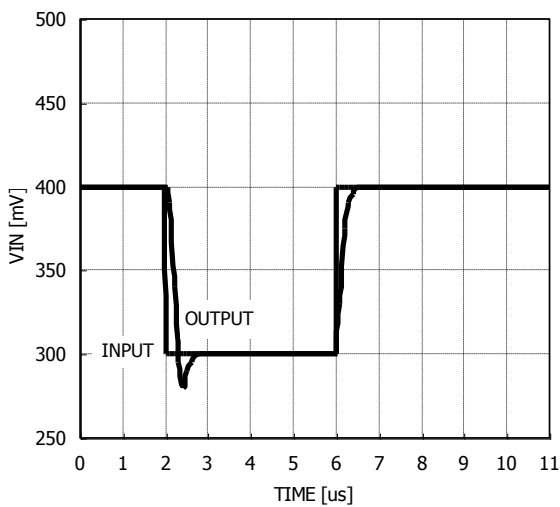

Voltage Follower Pulse Response (Small Signal)

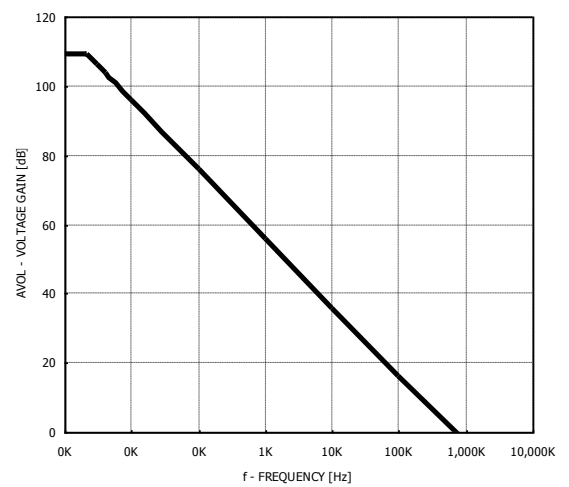

Open Loop Frequency Response

REVISION NOTICE

The description in this datasheet can be revised without any notice to describe its electrical characteristics properly.